

Tiger Bipe 40



Item No. 4557



Assembly Instructions

WARRANTY

Thunder Tiger Model Company guarantees this model kit to be free from defects in both material and workmanship at date of manufacture. This warranty does not cover any components damaged by use or modification and in no case shall Thunder Tiger's liability exceed the original purchase price of the kit. Thunder Tiger also reserves the right to change or modify this warranty without notice.

Since Thunder Tiger Model Co. has no control over possible shipping damages or construction techniques and materials used for construction by the modeler, no liability can be assumed nor accepted for damage resulting from the use by the user of the final user-assembled product. By the act of using this user-assembled product, the user accepts all resulting liability. If the buyer is not prepared to accept this liability, he should return this kit in new and unused condition to the place of purchase for a full refund.

INTRODUCTION

All of us at Thunder Tiger want to thank you for choosing the best looking, easiest building and best flying ARF biplane available, the Tiger Bipe 40. This kit features state-of-the-art engineering that provides quick and easy assembly of a strong, yet lightweight airplane that will give you an enjoyable and thrilling experience. The Tiger Bipe will allow you to enjoy model airplanes the way they were meant to be: with two wings!

To gain the most from this airplane kit, it is important that you read the instructions thoroughly and then follow them exactly. We strongly suggest that you read through the instructions completely before beginning construction. This will give you a good idea of the construction sequence and eliminate many questions you might have if you did not read the manual prior to starting the actual construction. Due to the nature of this design, this airplane is not intended for a beginner's first model and the instructions are written with this in mind. We assume you have a working knowledge of airplane and radio terminology.

The first thing you should do before beginning assembly is to check the contents of your kit against the parts list on pages 4 and 5. If any parts are missing, contact your dealer immediately for replacement. Customers in the United States and Canada may contact **Ace Hobby Distributors at 116 W. 19th Street, Higginsville, MO 64037** (660) 584-6704 for replacement parts. *Under no circumstances can a kit be returned if assembly has already been started.*

TABLE OF CONTENTS

Introduction	2
Other Items Required	2
Items Need Check List	3
Parts List	4-5
Pre-Assembly Notes	6
Wing	7
Landing Gear	8
Tail	9-10
Engine	11
Tank	12
Install the Radio	13-14
Cowl	15
Flight	16-17
Safety	18

OTHER ITEMS REQUIRED FOR ASSEMBLY

A checklist is also provided on the next page which will make shopping for these items easier.



Radio - A 4-channel radio with four standard servos is required.





Adhesives - You will need two types of adhesives for the Tiger Bipe - Epoxy and Instant (cyanoacrylate) adhesives. We recommend that you purchase both 5-minute and 30-minute epoxy to cut down on assembly time, but you can get by with only 30-minute epoxy if time is not important. You will also need a small bottle of both "Thick" and "Thin" instant adhesive.



Tools - Model assembly can be much easier if the proper tools are used. Therefore, we have included in our checklist to the right, a complete listing of all the tools we used to assemble our prototype models. As you will notice, many household tools can be utilized during construction.



Engine - The Thunder Tiger PRO-36 is the ideal engine for this airplane. It is a quiet running engine that is easy to start and require no special break- in period, is very easy to maintain, and will last for years.

Flight Equipment - There are several "support" items that you will need to purchase in order to get your engine running and your plane in the air. These are listed at the bottom of the page.



Comprehensive Items Needed Check List

- 4-Channel Radio with 4 Standard Servos
- 5-Minute Epoxy (4 ounces or so)
- 30-Minute Epoxy (4 ounces or so)
- "Thin" Instant Adhesive (1/2 ounce)
- "Thick" Instant Adhesive (1/2 ounce)
- Hobby Knife and Blades
- Epoxy Mixing Sticks and/or Brushes
- Sandpaper (150 grit)
- Masking Tape
- Rubbing Alcohol
- Paper Towels
- Ruler
- 90 Degree Triangle
- Waxed Paper
- Fine-Point, Felt-Tip Pen
- Misc. Household Tools
- Drill and Bits (1/16", 5/64", 3/32", 5/32", 3/16")

Flight Equipment

- Foam Rubber Padding for the radio
- Stick on Lead Strip for balancing the plane
- 3 or 4 Props (see engine instructions)
- 10%-15% Glow Fuel
- Fuel Pump or Bulb
- Electric Starter or "Chicken Stick"
- Glow Plug Clip and Battery
- Extra Glow Plug(s)

IMPORTANT

Please check the contents of your kit box with these part sketches before beginning construction. This will not only familiarize you with the parts and their names, but it will also give you a head start in the unlikely event that you are missing a part.

AS6119 Fuselage Set

Fuselage(1)
2 x 8mm Self-Tapping(4)
Servo Tray(1)

PE0009 Hardware Set

Allen Wrench(1)
Push Rod Connector(1)
3 x 3mm Set Screw(1)
2mm Hex Nut(1)

AS6120 Main Wing Set

Top Left Wing(1)
Top Right Wing(1)
Bottom Left Wing(1)
Bottom Right Wing(1)
Front Wing Dowel Doubler(2)
Rear Wing Dowel Doubler(2)
CA Hinge(6)
Washer(2)
Wing Dowel(1)
Aileron Horn Torque(2)
Wing Bolt 6/32 x 24mm(2)
Aileron Servo Tray(2)
Bottom Wing Joiner(2)
Top Wing Joiner(2)
Trim Tape(2)

AS6121 Tail Feather

H. Stab./ Elevator(1)
V. Fin/ Rudder(1)
CA Hinge(8)

3102 Adjustable Engine Mount

Screw 6/32 x 18mm(4)
Screw 3 x 15mm(4)
Engine Mount Plate(1)
Beams(L/1 R/1)

AS6122 Pushrod Set

Stab Pushrod(1)
Rudder Pushrod(1)
0.05" Metal Pushrod(1)
Plastic Guide Tube(1)
Clevis(5)
Aileron Pushrod(2)

3261 Fuel Tank Set

Silicone Tube(1)
Cap(1)
Clunk(1)
Rubber Stopper(1)
90-degree Nipple(1)
Straight Nipple(1)
180cc (6oz)
180cc Fuel Tank(1)

Parts are not necessarily drawn actual size!

Replacement parts must be ordered by Set Number

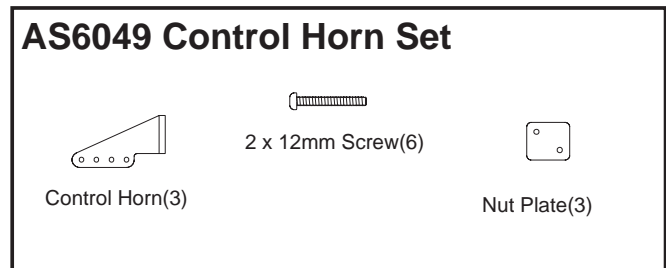
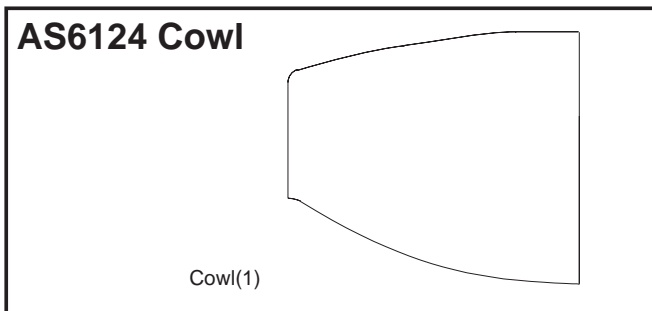
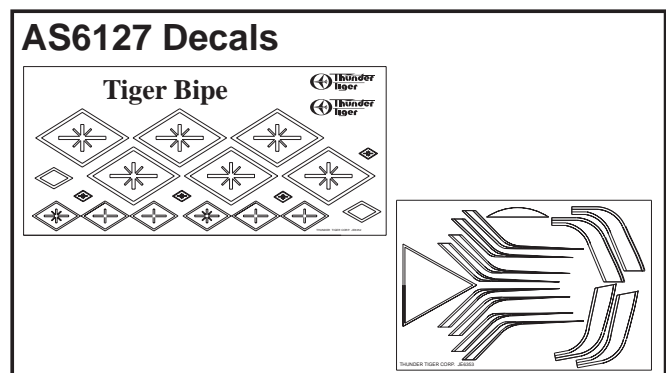
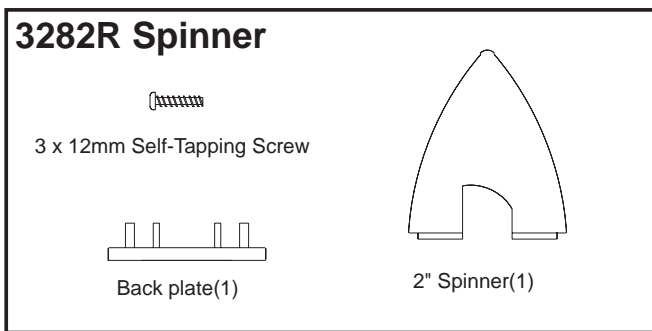
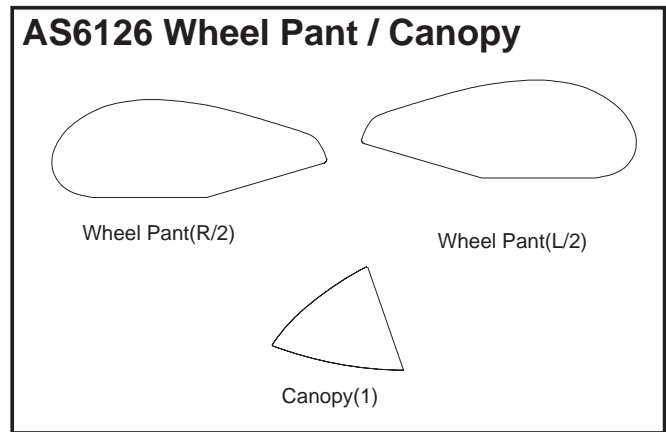
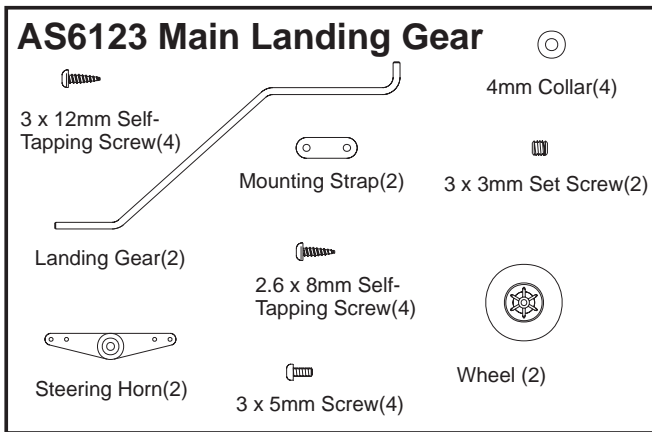
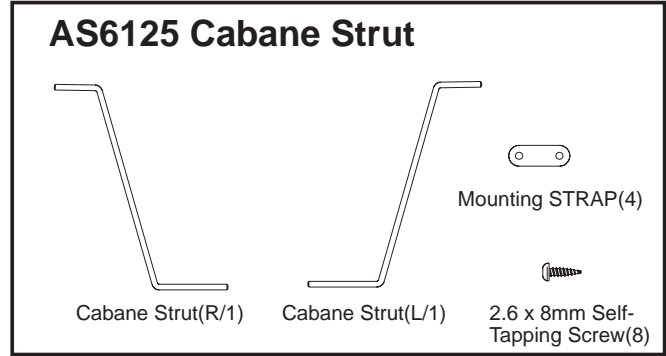
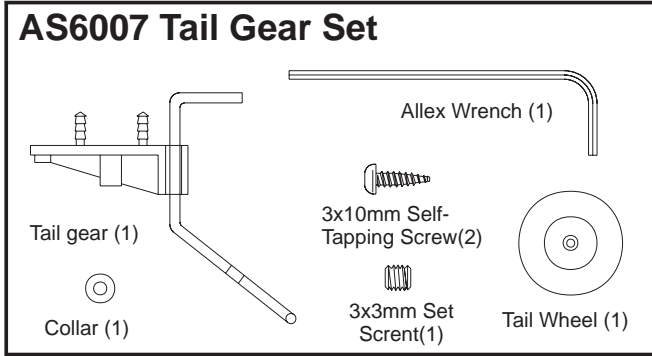

Parts are not necessarily drawn actual size!

PRE-ASSEMBLY NOTES

1. Please assemble your model according to these instructions. Do not attempt to modify or change in any way as doing so may adversely change its flying characteristics.
2. Before you begin, please check the entire contents of this kit against the parts list and photo to make sure that no parts are missing or damaged. This will also help you to become familiar with each component of your plane. If you find that any of the parts are either missing or damaged, please contact your dealer immediately for replacement.
3. Each step of these instructions is preceded by a box which can be checked off as you complete the step. This will allow you to follow your progress and quickly find your starting place after any interruptions or breaks.

Note: Your dealer cannot accept kits for return if construction has begun.

WING ASSEMBLY

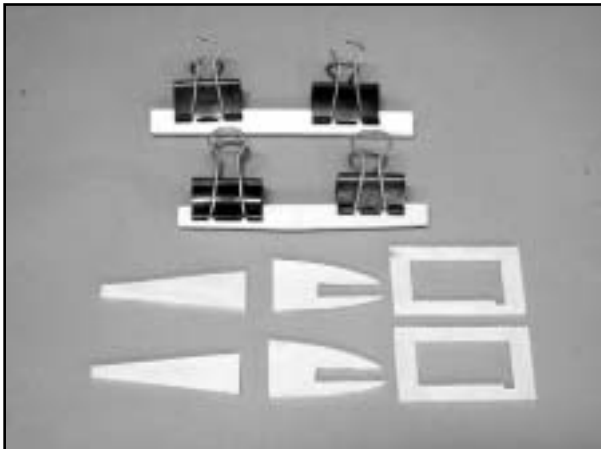

❑ Locate the following pairs of plywood parts: top and bottom wing joiners, front and rear wing dowel doublers, and aileron servo tray. Using epoxy or thick CyA, glue and clamp these pairs of pieces together to form 6mm thick parts. Keep the edges of the pieces lined up and wipe off any excess glue.

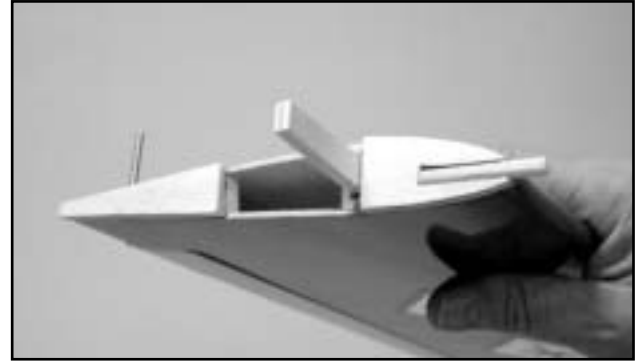

❑ Note: the bottom wing is shorter than the top wing and has ailerons. Before gluing the two wing halves together, trial-fit the bottom wing joiner into both wing panels. If it is not easy to slide into the wing, sand it until it will. Note: this joiner is the shorter of the two and has more angle in it. To fit properly, note that the wing has an upward “bend” in it, called dihedral. While fitting, also have the front and rear wing dowel doublers temporarily in place.

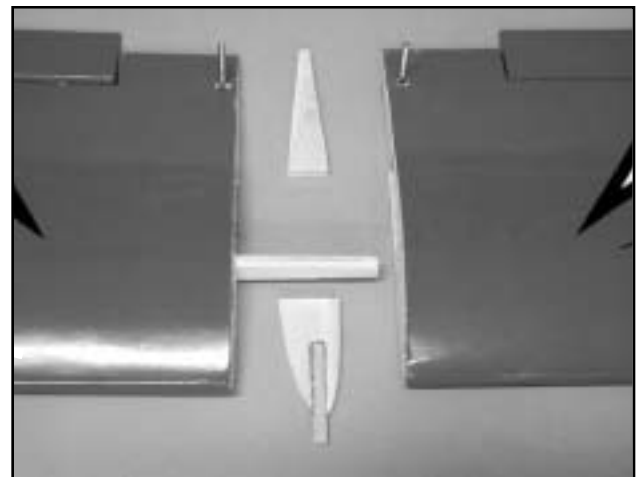

❑ With 30 minute epoxy, liberally coat all sides and edges of the wing joiner and slip it into one wing half. Now coat the inside edge of the center wing rib where it will join to the other wing half. This is called the “root” of the wing.

Put the front and rear wing dowel doublers in place WITH THE WING DOWEL PLACED IN ITS SLOT.

Now coat the root edge of the other wing panel with epoxy.

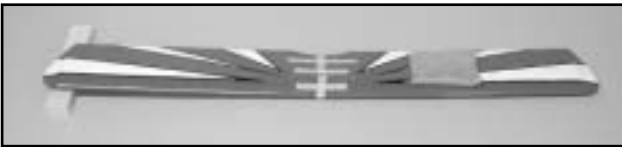
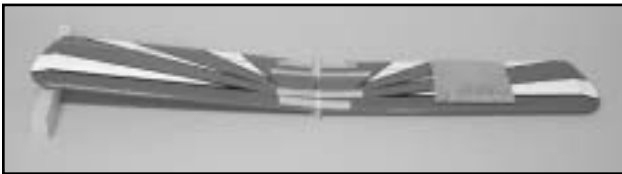
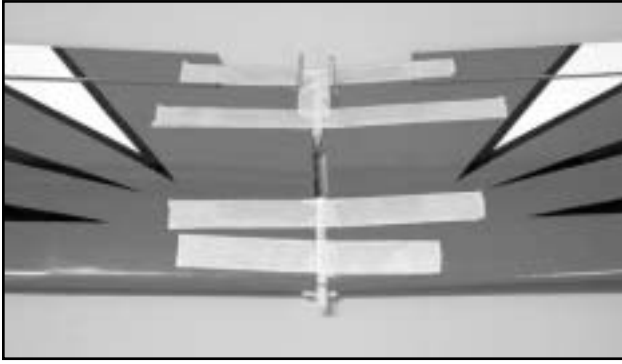

❑ Join the two wing halves and firmly press wing panels together. Wipe off any excess epoxy with a paper towel and rubbing alcohol. Make sure the two panels are accurately aligned with each other and hold together with several strips of masking tape.

To make sure you have the correct amount of dihedral, place the wing on a flat surface; keep one wing half flat on the surface and prop up the other panel so there is 2" under the rear part of the tip rib. Loosen the tape if necessary.

❑ Repeat for the top wing with two differences...there are no wing dowel doublers and the total amount of dihedral is 3/4".

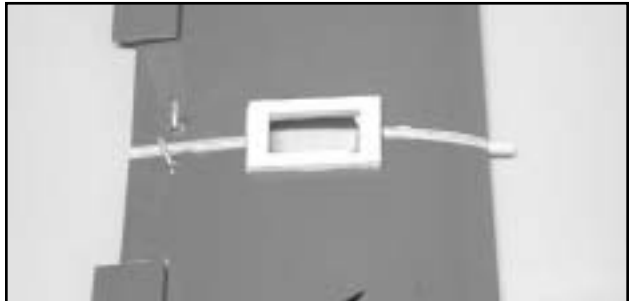
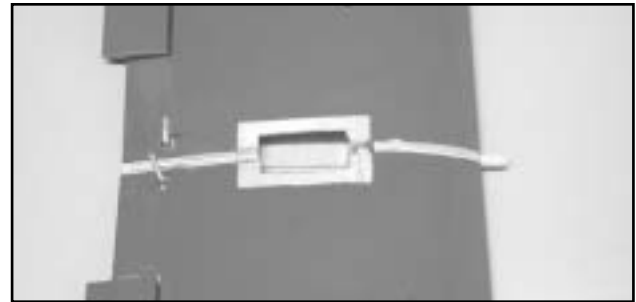
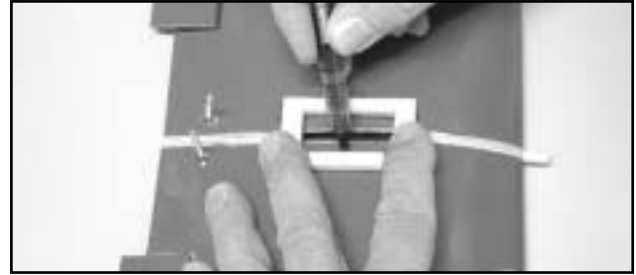

❑ Place the servo tray in the middle of the top surface of the bottom wing. Line it up with the rear INNER edge aligned on the rear dowel doubler. Mark around the inside and outside of the servo tray with a felt tip pen.

❑ Remove the tray, and use a sharp knife to cut through and remove the covering material and balsa where you marked the INSIDE of the servo tray.

❑ Use a sharp knife to score the covering material where marked around the OUTSIDE of the tray. Remove the covering material to expose the wood underneath. Use thick CA or epoxy to glue the servo tray securely in place.

❑ Strips of covering film are provided to trim out the center joint. You will need to use a covering iron or a household iron to secure the film.



❑ To hinge the ailerons, remove the clear tape that hold the ailerons in place, if necessary. Pull the aileron off the wing, revealing the hinges. Center these hinges in their slots in the AILERON and secure them with THIN CA, letting it wick into the joint. Glue both surfaces of the hinge.



❑ When the glue has set, re-install the aileron onto the wing. Hint: if you trim a little bit off each corner of the hinges, they will insert in the slots easier. While flexing the aileron one way or the other and while holding the wing up on it's front edge, carefully wick CA into the slot where the hinge goes into the wing. Do so on both sides of the hinge. After the glue has set, tug on the aileron at each hinge location to make sure the hinges are securely glued in place. Also, make sure the aileron is free to move up and down.

Repeat for the other aileron.

Set your wings aside, for now.

INSTALL LANDING GEAR

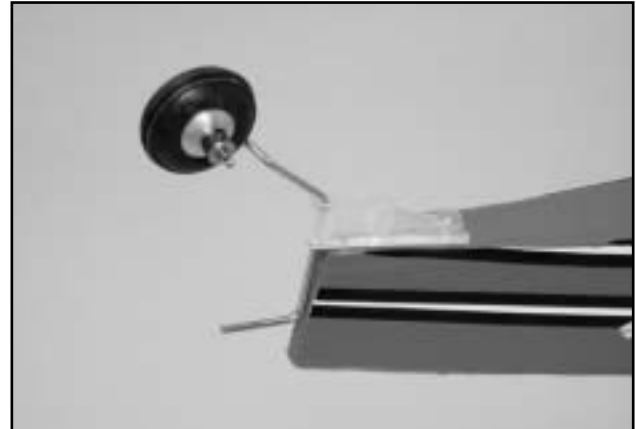

❑ Locate the tailwheel assembly. Observe that it is secured to the bottom of the fuselage with two barbed posts. Mark the locations for these posts on the rear of the fuselage so that the tiller arm of the tail wheel assembly will be flush with the rear edge of the fuselage. Drill 1/8" holes at these locations and push the tailwheel assembly's barbed posts into these holes. Your assemble should be secure. If you want, you can add some screws in the holes provided in the assembly (not furnished.) The tailwheel is secured with a wheel collar and set screw.

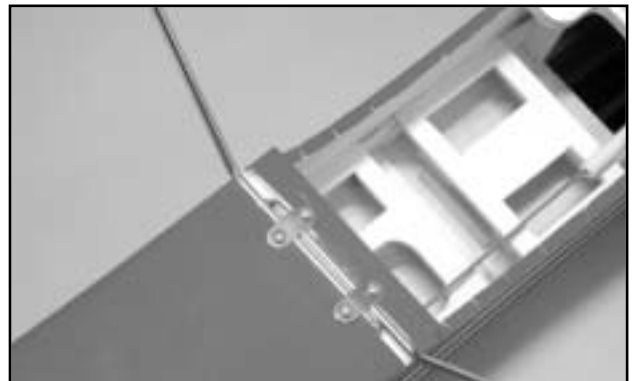

❑ Cut away the covering material that covers the slot for the main gear. Insert the vertical arm of one mail gear strut in the hole provided. Repeat for the other. Secure them in place with two landing gear straps and 3x10mm screws. (Drill 3/32" pilot holes first.)

The wheels and wheel pants will be added later.

Now that the plane is "up on its feet", it will be easier to work on.

INSTALL PUSHRODS

- ❑ Cut away the covering material over the two uppermost slots that are on the right and left sides of the fuselage at the rear.

Cut away the covering from the lowermost slot on the RIGHT side of the fuselage.

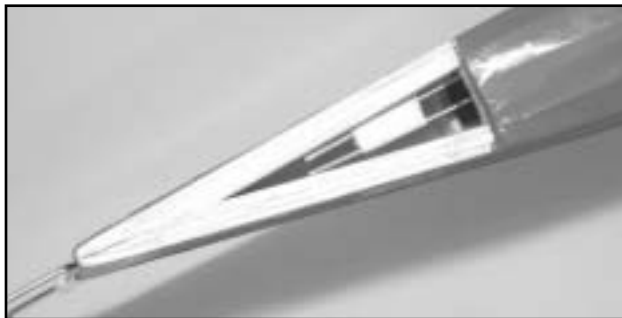
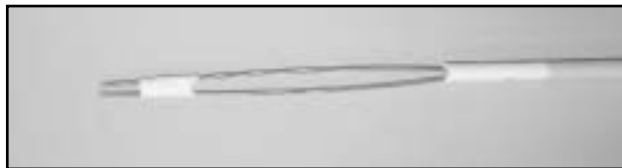

- ❑ Locate the elevator pushrod. It is the one with the two rods on one end.

Use a pliers and spread the two rods apart so they are about 2" apart.

- ❑ Now, use some tape to hold the two rods together so they are only about 1/2" apart.

- ❑ Insert this pushrod into the fuselage. Note: It is easiest to start at the opening in the tail, working from the tail end forward until the non-threaded end is in the radio compartment.

- ❑ Cut the tape loose so the rods can spread and let them come out the two uppermost slots in the fuse sides.

- ❑ In the same fashion, insert the rudder pushrod so the threaded end comes out the lower slot in the right side of the fuse.

INSTALL TAIL GROUP

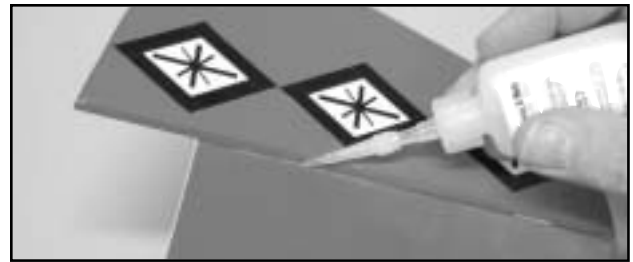

- ❑ CA the hinges into the rudder and stabilizer control surfaces using the same technique outlined for the ailerons.



- ❑ Trim the material away that covers a notch in the front of the stabilizer. On the top of the stab, use a straightedge and a pencil to extend the lines formed by the notch back to the rear of the stab. This marks the center of the stab.



- ❑ Position the stabilizer on top of the fuselage and line up the mark you just drew on top of the stab with the center of the fuselage; the rear edge of the fuselage should line up with the hinge line. Use a pencil to draw a line on the bottom of the stab along the fuselage sides.

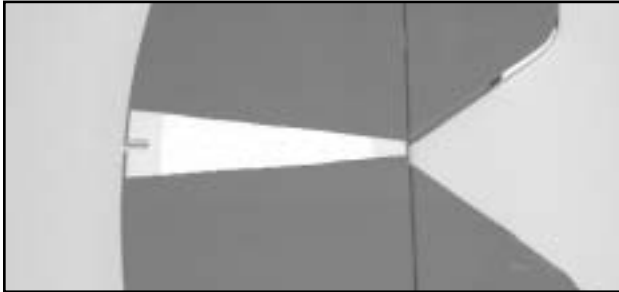

❑ Remove the stab from the fuselage and use a straight edge to carefully score the covering material where marked. Make the score approximately 1/16" inside the lines you drew. It is very important that you do not press hard enough to cut into the wood itself or the stabilizer may fail in flight. Just score the covering and it will peel away nicely.



❑ Glue the stab to the fuselage with epoxy, keeping the stab parallel with the work surface as the glue cures.

❑ Score and remove the covering material between the lines you drew on the top of the stab. The vertical fin will glue here.

❑ Move the rudder/fin into position and mark the location of the tail wheel assembly's tiller arm. Drill a 1/16" hole in the rudder to accommodate the arm. Making sure the tiller arm slips into the hole you just drilled, epoxy the fin to the stabilizer. Make sure the fin remains perpendicular to the stab as the glue cures.

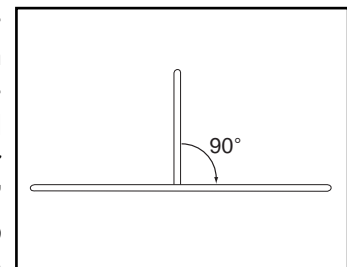

❑ Next, apply a second, liberal coat of epoxy to the joint where the fin joins the stabilizer. Form a fillet with the tip of your finger dipped in alcohol.

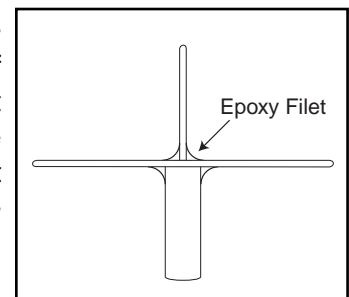

❑ Repeat this process for the stabilizer/fuselage joint.

INSTALL THE ENGINE

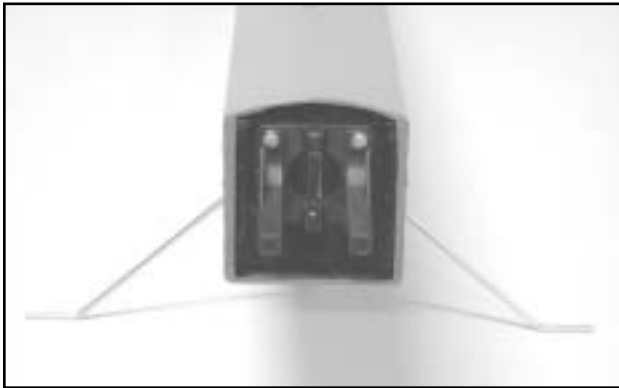

❑ Attach the engine mount plate and both mounting beams to the firewall using the 6-32 x 18mm screws provided. Make sure the mounting beam “webs” are on the outside of the mount. Do not fully tighten the four engine mount screws at this time.



❑ Set the engine on the mount and adjust the beams so they are almost touching both sides of the engine crankcase and are centered in relation to the engine mount back plate. Now position the engine so that the front of the thrust washer is approximately 4-1/4" from the fire wall. Mark the hole locations for the engine mounting screws in the engine mount beams.

❑ Remove the engine and drill a 3/32" hole at each of the four marks you just made. “Break-in” the mounting holes by inserting a 3 x 15mm sheet metal screw into each hole without the engine in place. A drop of oil in each hole may help the screws thread in easier.

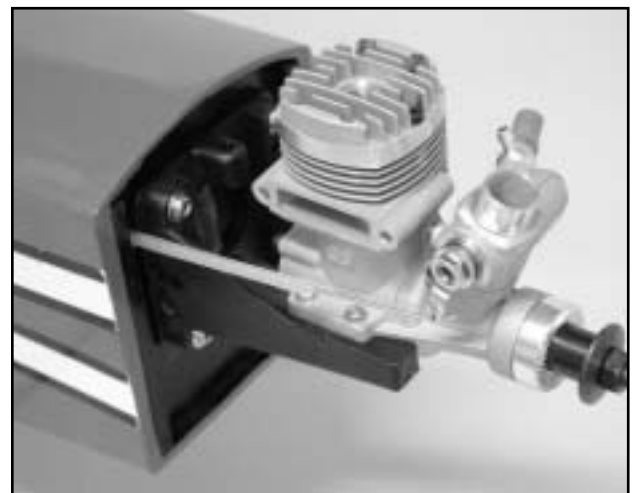

❑ With the engine in place, mark the spot on the firewall that is straight behind the throttle arm on the carburetor and adjacent to the engine mount back plate. This marks the hole for the throttle linkage tubing.

Drill a 1/8" hole in the firewall at this mark. Insert the furnished yellow “inner nyrod” into this hole. It will act as a housing for the .050" music wire throttle linkage.

❑ Locate the music wire throttle linkage and hook the “z” bend onto your engine’s throttle arm and move the engine into position. You may have to bend some jogs in the wire to prevent binding of the linkage. Screw the engine in place on the mount.

INSTALL THE FUEL TANK



□ Assemble the fuel tank by first cutting the silicone tube to 2-1/2" in length. Press the straight plastic nipple (the 90 degree nipple is not used in this plane) into the rubber stopper (Saliva will ease insertion.) Now slip the silicone tubing onto the nipple and insert the metal clunk into the other end of the tubing. Insert this assembly into the tank (clunk first) and securely tighten the threaded cap on to hold everything together.



□ Attach a 6" piece of standard fuel line (not furnished) to both the fuel outlet nipple and the vent nipple on the tank. The vent nipple is the top one with the hole.



□ Slide the fuel tank (cap end first) into the front of the fuselage, threading the fuel lines through the oblong hole in the firewall. The tubing coming from the tank's fuel outlet (center) goes to the carb and the tubing from the vent (upper) goes to the muffler's pressure fitting. Trim the length as needed. Wedge some pieces of foam rubber or "bubble wrap" (not furnished) beside and on top of the tank to gently hold it in place.

CABANE STRUTS



□ Locate the holes in the side of the fuselage for the cabane struts and cut away the covering material that covers them.



□ Insert the two preformed Cabane Struts in the holes as shown. As you look at them, they should form the letter "N". You may have to run a 1/8" drill bit in the holes to ease insertion.

RADIO INSTALLATION



❑ Locate the three control horns and 2x12mm screws. Also locate three of the nylon clevises. Thread a clevis onto the rudder control rod until about 1/8" of threads are showing on the inside of the clevis body. Snap it onto the outer hole in one of the control horns. Position the horn on the rudder so the holes line up with the hinge line. (For smooth operation, you may have to bend the pushrod so it runs parallel to the fuselage.) Mark and drill 3/32" holes for the mounting screws and secure the horn with two screws and the nylon nut plate.

❑ Repeat for the two elevator pushrods.

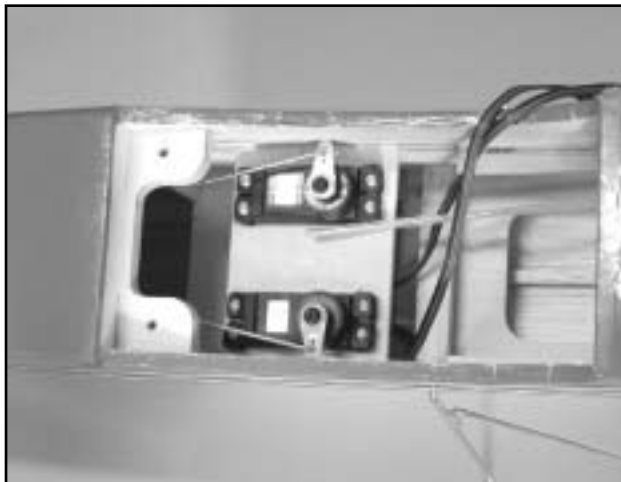

❑ Mount two servos on the servo tray which is already installed in your fuselage. These are for elevator and rudder. Note their orientation in

the photo. Follow your radio's instruction manual and make sure you use the grommets, eyelets, and screws furnished with your radio. Drill 1/16" pilot holes for the mounting screws before insertion.

❑ Hook the pushrods to the servo arms marking the proper length and making "Z" bends in the wire ends. A Z-Bend Pliers is a handy tool for this purpose. Note that the rods hook on the outside of the servo. This is to allow room for the aileron linkage when the wing is installed.

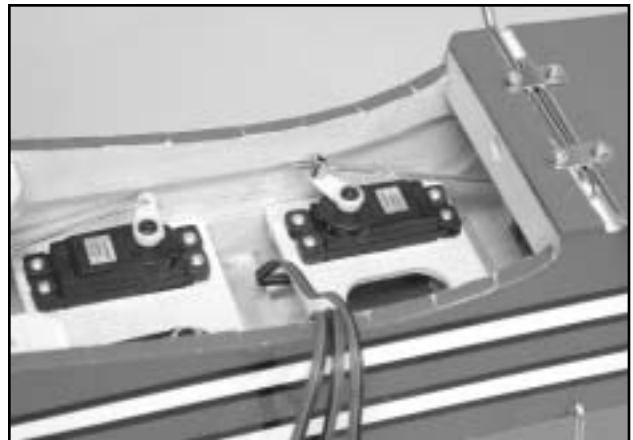

❑ Mount the throttle servo tray into place with four 2x8mm self-tapping screws in the fuselage so the cutout for servo corresponds with your throttle linkage. Mount the servo in place and hook the throttle pushrod to the servo arm with the "EZ Connect" furnished. Secure the body of the EZ Connect to the arm with the small nut furnished. Use the set-screw furnished to lock the throttle pushrod wire in place. Trim the nylon tube and wire as needed.

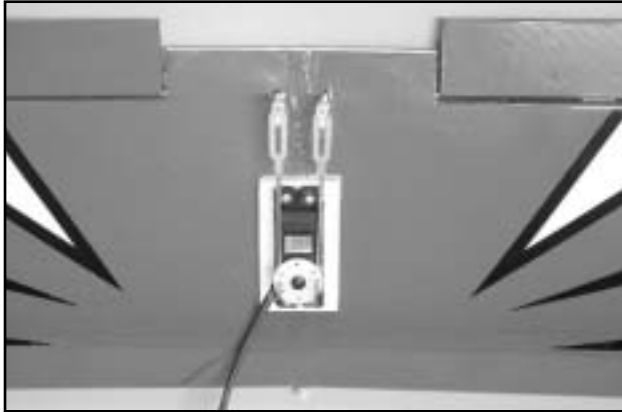

□ Mount the aileron servo in the bottom wing as shown. Screw the nylon horns furnished onto the threaded ends of the aileron torque rods; screw down until about 1/16" of threads are exposed above the horn. Use the threaded rods, clevises, and "Z" bends to link the servo to the ailerons.

Adjust the linkage so the bottom surface of the wing is consistent with the bottom surface of the ailerons when the servo is in neutral.

□ When all is complete, install the receiver, switch harness, and battery pack. The receiver can go in the cutout in the throttle servo tray and a flat battery pack will fit under the fuel tank. You may need to reposition the battery to achieve proper balance.



□ Trim the rear of the cowl to remove the molding flange. Make cutouts as needed to clear the prop shaft, cylinder head, carb, and muffler. A sanding wheel on a Dremel tool is handy for this.

With the cowl in position, drill 1/16" holes for the small mounting screws in four places. Locate them in the white area on the fuselage side.

After the cowl is mounted, add the sticky backed trim material to dress up your cowl.

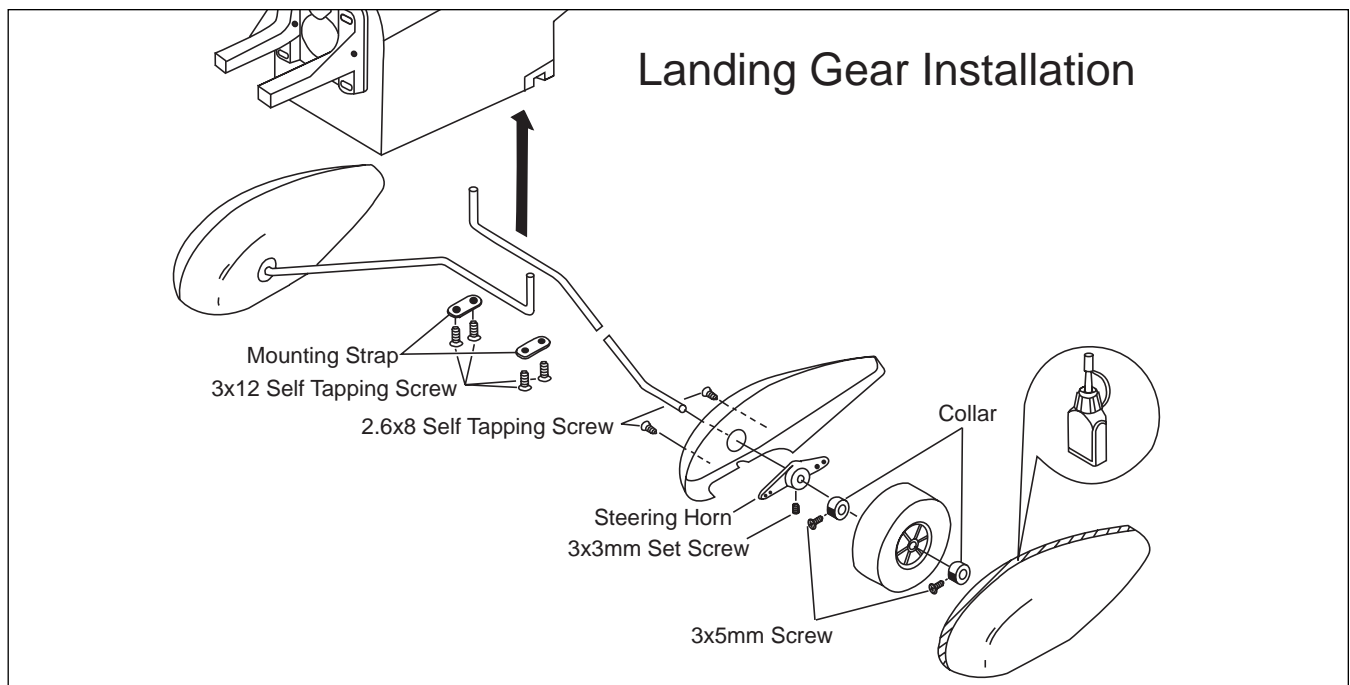

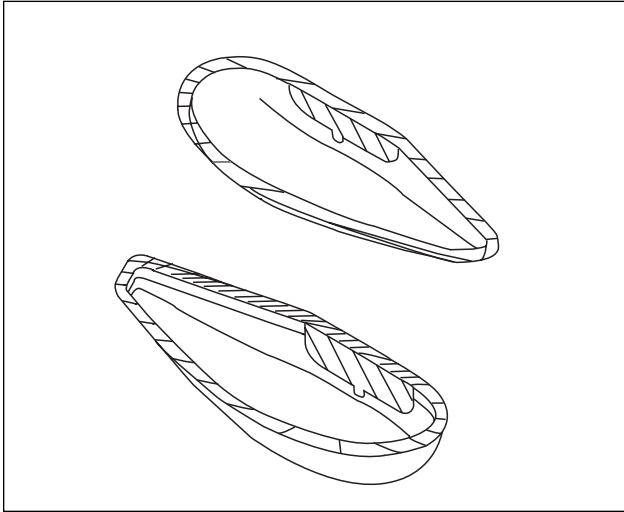

❑ Assemble and mount the wheel pants according to the drawing.

Add the trim material furnished to dress up the pants.



❑ Trim the excess plastic from the clear wind shield and glue it in place with RC-56 canopy glue or thick CA.

WING ATTACHMENT

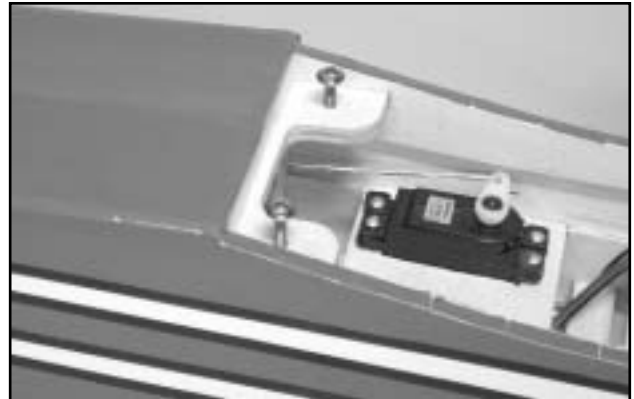

❑ The bottom wing is secured by means of two 6-32 bolts. The blind nuts are already installed in the hold-down plate in the fuselage. Run the bolts into the blind nuts so the head is about 1/2" from the hold-down plate.

Put the bottom wing in position with the dowel going into the hole in the fuselage former. Keeping the wing perpendicular to the fuselage, press the wing into the bolts you just installed so you leave an impression in the wood.

Remove the wing and, using the impressions you just made, drill two 3/16" holes in the wing for the bolts.

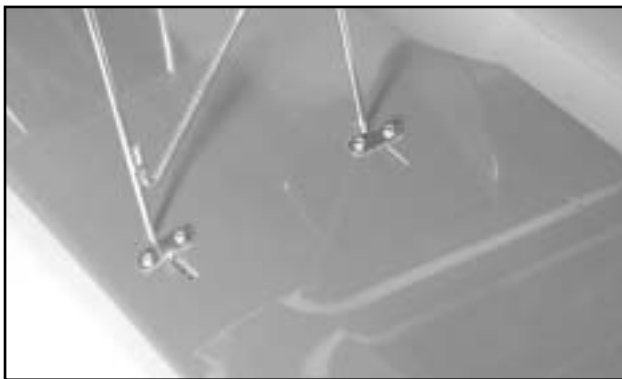
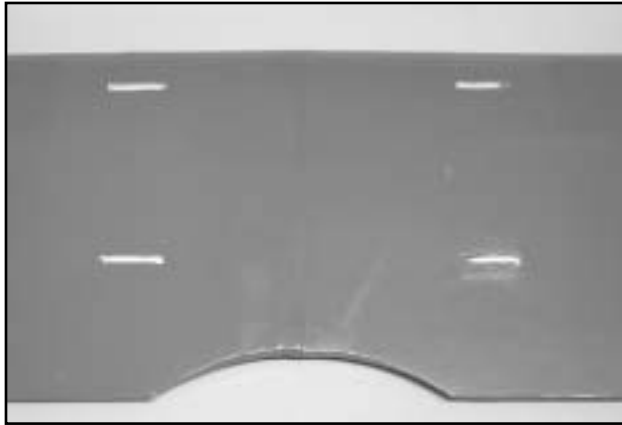

❑ To attach the top wing, begin by removing the covering material over four slots in the bottom surface of the top wing.

Put the top wing upside down on your work surface using a piece of foam or a towel to protect the wing.

Place the cabane struts into position so the wire is engaged in the slots you revealed earlier. The wing is held in place with four metal straps and small self-tap screws. Position the straps close to the bend in the struts. Pre-drill for the screws with a 1/16" drill.

BALANCE and SURFACE THROWS

IMPORTANT- Do not attempt to fly your model before completing this very important section. A model that is not properly balanced will be unstable and could cause serious damage and/or injury.

❑ The balance point for this model is 1/4" behind the main spar of the top wing, fully assembled but without fuel.

Once you have everything positioned as necessary, wrap your receiver and battery pack in 1/4" or 1/2" thick foam for protection.

❑ Using the switch cover as a template, cut an opening in the side of the fuselage to mount the switch in. It should be on the left side of the fuselage. Drill two 1/16" holes for the switch mounting screws and install the switch. Drill a 1/16" hole through the fuselage side, about one inch behind the switch mount. From the inside out, thread the receiver antenna through this hole. You may want to tie a knot in the antenna 3" or 4" from the receiver to act as a strain relief. Attach the end of the antenna to the top of the vertical fin with a small #10 rubber band and a T-pin. Maintain only a slight amount of tension on the antenna wire.

❑ Set-up your radio so the airplane has the following throws. Make sure the directions of the surfaces corresponds with the commands from the transmitter; i.e., right is right and up is up.

Rudder = 3/4" Right and Left

Elevator = 1/2" Up and Down

Ailerons = 5/16" Up and Down

(Throws are measured at the rearmost edge of the surface.)

Balance Point = 1/4" Behind Top Wing Main Spar

LOCATE A GOOD FLYING SITE

Generally, the best place to fly your model is at an **AMA** (Academy of Model Aeronautics) chartered club field. Your local hobby dealer can tell you if there is such a club in your area or write the AMA for information. It is also a good idea to join this organization before flying your model since they offer liability insurance that can protect you if your model causes damage or injury to others.

Academy of Model Aeronautics
5151 East Memorial Dr.
Muncie, IN 47302-9252

If there is not a chartered club field in your community, you will need to find a large area free of obstructions, that has a smooth grass or asphalt surface to be used as a runway. For safety's sake, it should be located well away from houses, building, schools, power lines and airports. If you will be flying within 6 mile of an airport, you should check with the airport manager before flying your model.

A NOTE ON BATTERIES

The batteries are the heart of your radio system. Make sure you have fully charged batteries! With rechargeable batteries, follow the manufacturers instructions to make sure the batteries are fully charged, especially the first time the radio is used.

If your radio uses dry cells, make sure your batteries are in new condition. You have a lot of money invested in this project so it is not worth the risk of using old batteries.

FLYING YOUR TIGER BIPE

You will find your Tiger Bipe very enjoyable to fly. It is quite aerobatic and capable of very "snappy" maneuvers.

You will find this tail-dragger has great ground handling and only requires a touch of right rudder when you power-up. Let the airplane's tail come up and fly it off the ground, don't horse it off with up elevator. The most appealing aspect of flying this airplane is the visual impact of a biplane. It puts you back to a "Waldo Pepper" time when airplanes had to fly on the wings, not on the prop. Fly your Tiger Bipe the same way. Keep the maneuvers large and smooth. When you are ready to tighten up the maneuvers, gradually add some weight to the tail to bring the CG rearward.

Landings are a breeze. Just adjust the altitude of the plane with the throttle, and the attitude with the elevator. Nothing is nicer than a biplane making a perfect three-point landing.

PRE-FLIGHT CHECKS

You should perform these checks before each flying session.

- 1. Check all control surfaces for possible looseness or deterioration.
- 2. Check all screws, clevises, nuts and all other connectors to make sure they are securely fastened.
- 3. Check which radio frequencies are being used. Do not turn on your radio until absolutely sure you are the only one operating on that frequency.
- 4. Check for proper operation of all control surfaces.
- 5. Check the level of charge in both the transmitter and receiver batteries before flying.
- 6. Range check the radio both with and without the engine running! Follow the radio manufacturers instructions for this.

POST-FLIGHT CHECK LIST

- ❑ 1. Be sure that both the transmitter and receiver switches are turned off.
- ❑ 2. Drain all excess fuel from the tank. Fuel left in the tank for extended periods can “gunk up” the tank, fittings and carburetor.
- ❑ 3. Clean the plane with paper towels and a light-duty spray cleanser. Keeping your plane clean will make it last longer and keep it looking nice.
- ❑ 4. Put a few drops of after-run or light oil in the carburetor and turn the prop over a few times (without the glow plug ignited) to distribute the oil throughout the engine.
- ❑ 5. Inspect the prop and replace it if any chips or cracks are found.
- ❑ 6. Inspect the entire plane for covering tears, new dings and dents, loose screws and connectors and any other wear and tear.
- ❑ 7. Use a voltmeter to check the receiver battery voltage. If it is low, you now know not to fly so long next time. If it is still high, you should be able to fly a little longer next session.

SAFETY PRECAUTIONS

1. Wear safety glasses when starting and running all model engines.
2. Model engine fuel is very flammable and the flame is very dangerous because it is almost invisible! Do not smoke or allow sparks, high heat or other flames near the fuel.
3. Do not run model engines inside a garage or other closed room as they give off large amounts of deadly carbon monoxide gas.
4. Do not run model engines around gravel, sand or other loose debris. These materials will be ingested through the carburetor and can also be kicked up by the prop.
5. Always stay behind the propeller when the engine is running. Make all engine adjustments from behind the engine. Under no circumstances should you allow your face or body near the plane on rotation of the propeller when the engine is running.
6. Do not allow loose clothing or other loose objects close to the prop.
7. To stop an engine, cut off the fuel or air supply to the engine. Do not throw rags or other objects into the prop to stop the engine.
8. Do not touch the engine or muffler during or right after it has been running—It gets very hot!
9. If you hear any unusual noises while your plane is flying, land at once and determine the problem before returning to the air. Control surface flutter, which often emits a low-pitched “buzz”, can quickly destroy an airplane and should not be ignored. Flutter is usually caused by sloppy control surfaces and is generally relatively easy to cure.